

L20
SD018

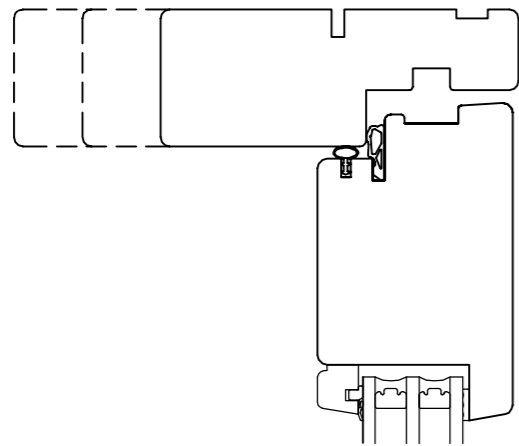

V20
SD019

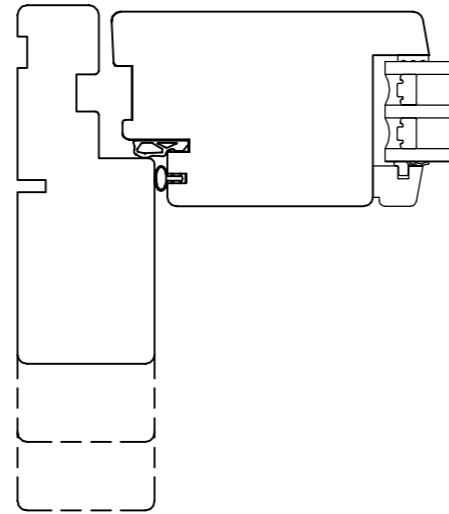

V20-1
SD019

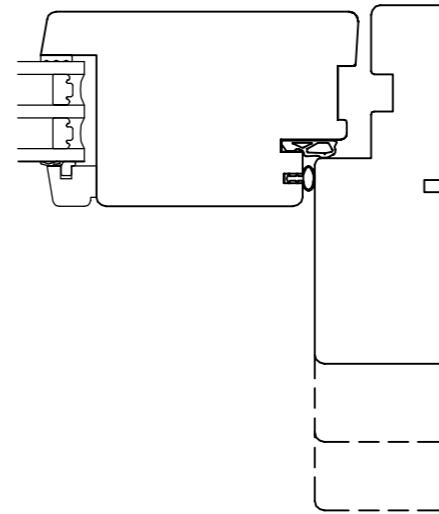

BONDEHUSPROFIL
KAN VÆLGES



OPFYLDER IKKE
NIVEAUFRI ADGANG

ALU

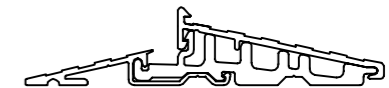

L25
SD016

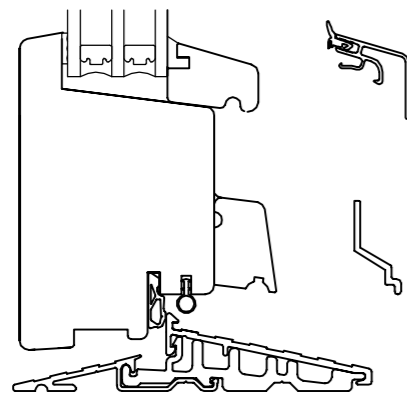

V20-1-P
SD043

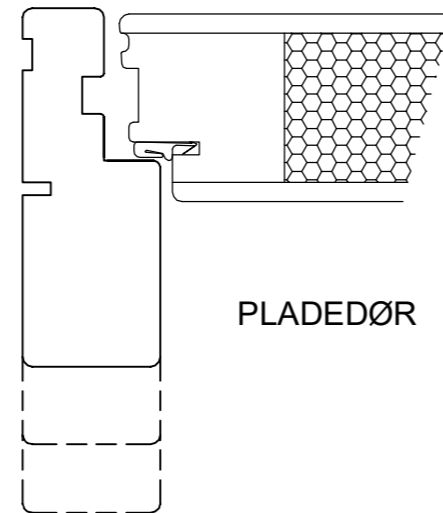

PLADEDØR



KAN VÆLGES

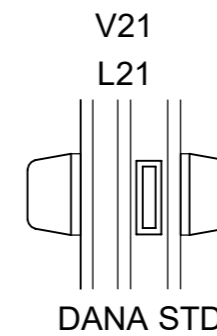

DANA STD.

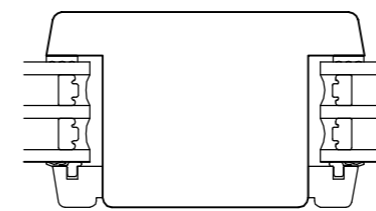

KAN VÆLGES

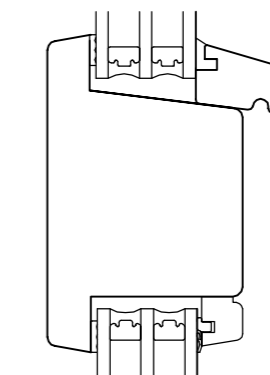

KAN VÆLGES

V24

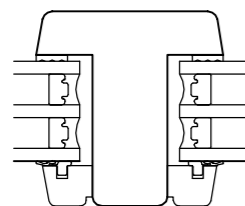

L24

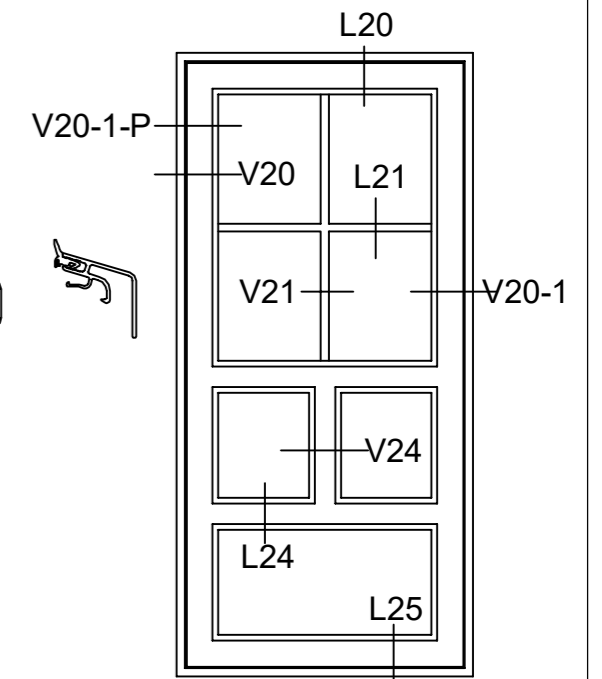
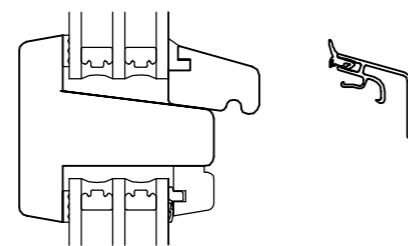

Fabriksvej 4
6973 Ørnshøj
Tlf 97 38 45 00
Tilbud@dana-vinduer.dk
www.dana-vinduer.dk

Facadevinduer og -døre i fyrretræ, træ/alu, mahogni og eg

DANA TIMBER +

DATO:	SIGN:	MÅL:
10-01-17	GSC	1:10
27-06-17	GSC	
09-01-18	GSC	

TEGNINGSNUMMER:
**INDADGÅENDE
DØRE 7**

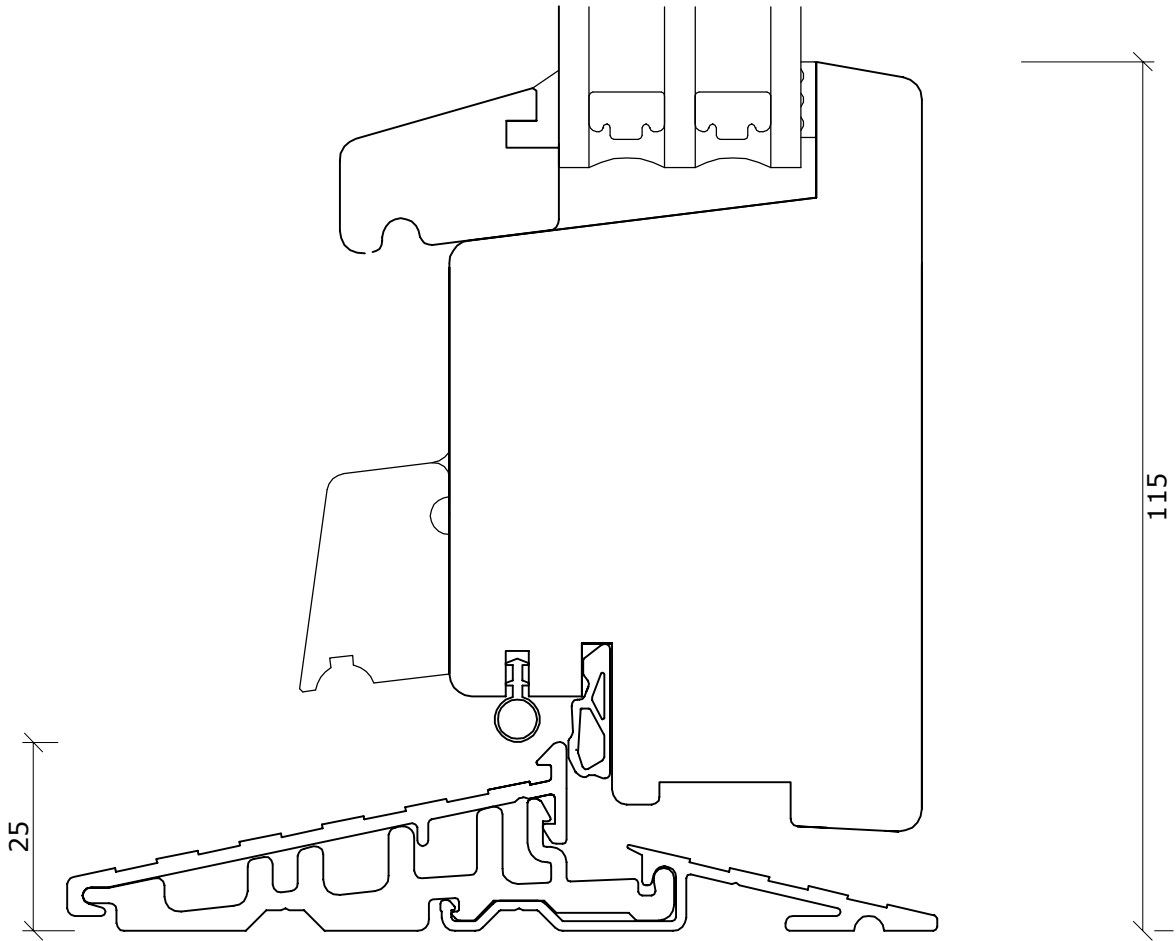

Fabriksvej 4
 6973 Ørnhøj
 Tlf 97 38 45 00
 Tilbud@dana-vinduer.dk
 www.dana-vinduer.dk

Snit i alubund bundkarm/ramme mahogni softline
 Indadgående døre

DATO:	SIGN:	MÅL:	TEGNINGSNUMMER:
30-10-15	GSC	1:1	SD016-M

Facadevinduer og -døre i fyrretræ, træ/alu, mahogni og eg

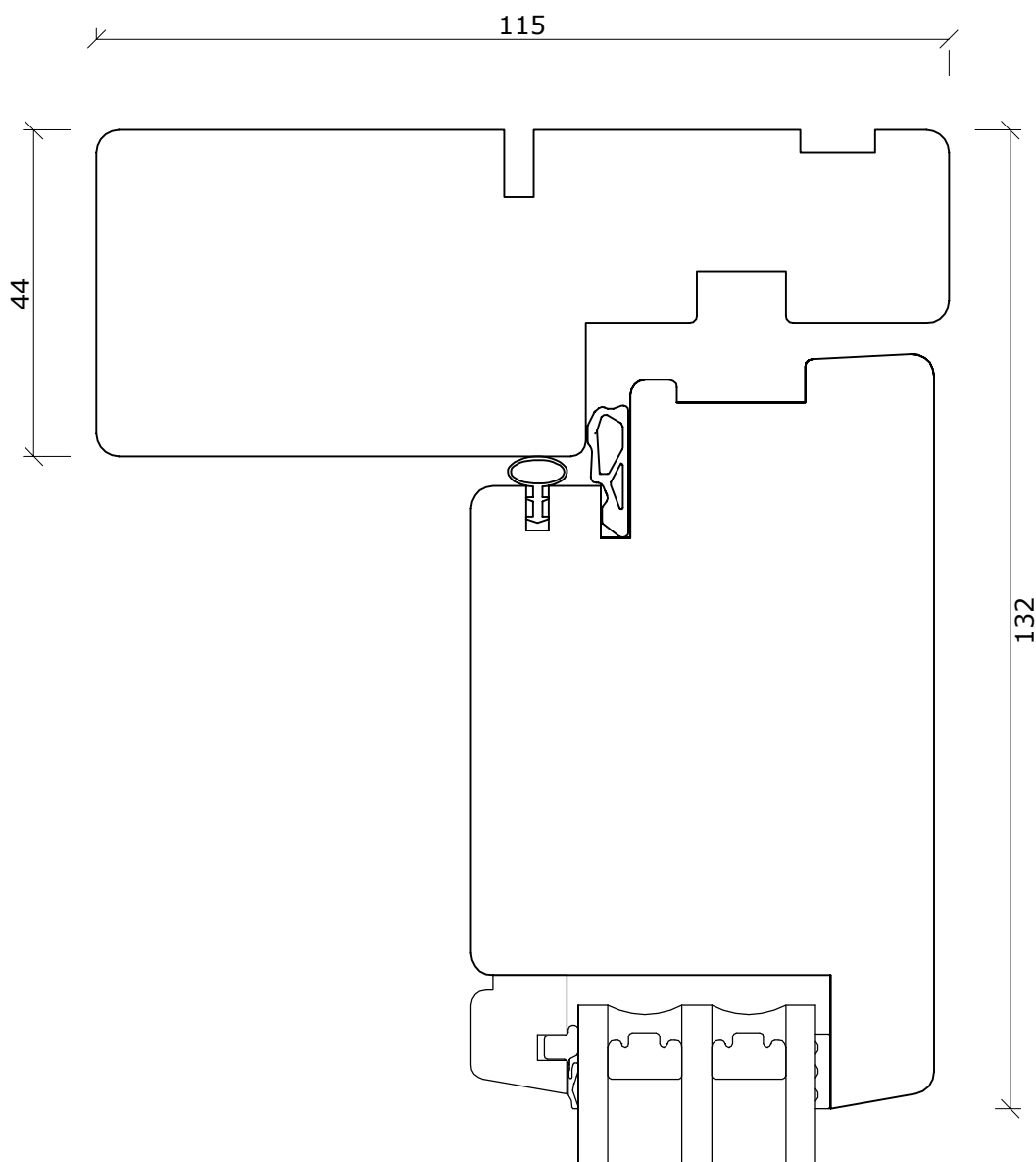

Fabriksvej 4
 6973 Ørnhøj
 Tlf 97 38 45 00
 Tilbud@dana-vinduer.dk
 www.dana-vinduer.dk

Snit i overkarm/ramme softline mahogni Indadgående døre

<table border="1"> <tr> <td>DATO:</td> <td>SIGN:</td> <td>MÅL:</td> <td rowspan="2">TEGNINGSNUMMER:</td> </tr> <tr> <td>30-10-15</td> <td>GSC</td> <td>1:1</td> </tr> </table>	DATO:	SIGN:	MÅL:	TEGNINGSNUMMER:	30-10-15	GSC	1:1	<h1>SD018-M</h1>
DATO:	SIGN:	MÅL:	TEGNINGSNUMMER:					
30-10-15	GSC	1:1						

Facadevinduer og -døre i fyrretræ, træ/alu, mahogni og eg

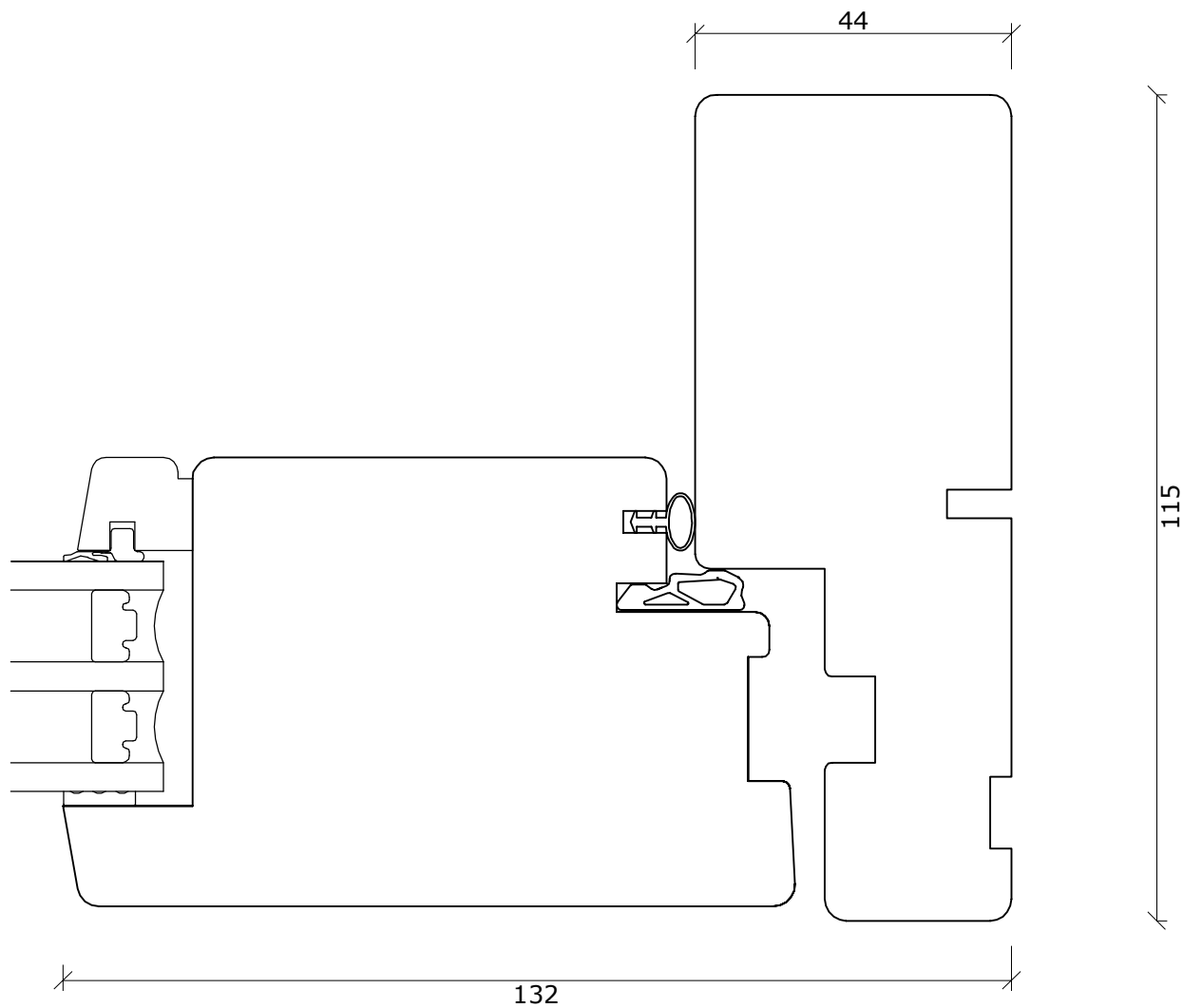

Fabriksvej 4
 6973 Ørnhøj
 Tlf 97 38 45 00
 Tilbud@dana-vinduer.dk
 www.dana-vinduer.dk

Snit i sidekarm/ramme mahogni softline Indadgående døre

DATO:	SIGN:	MÅL:	TEGNINGSNUMMER:
30-10-15	GSC	1:1	SD019-M

Facadevinduer og -døre i fyrretræ, træ/alu, mahogni og eg

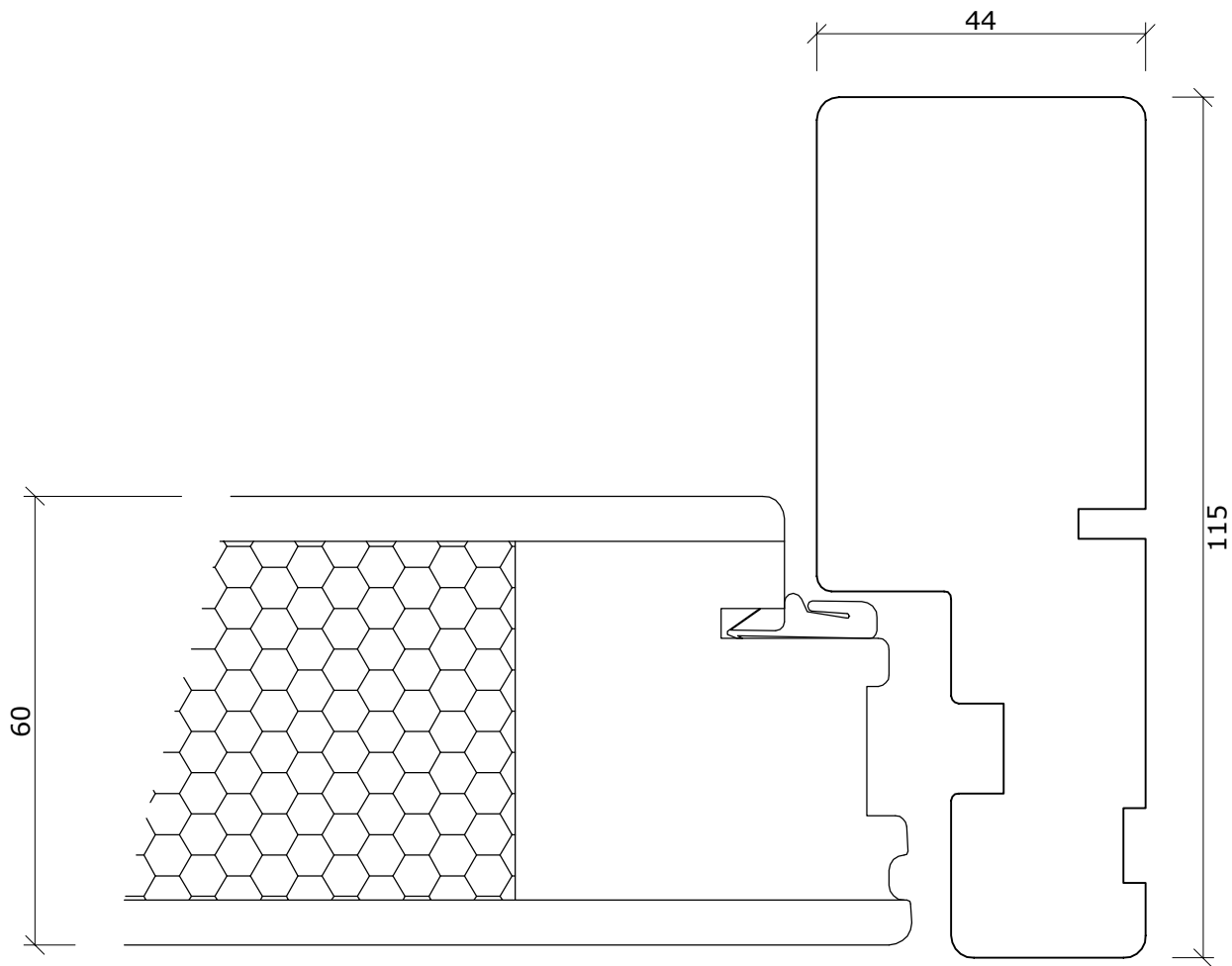

Fabriksvej 4
 6973 Ørnhøj
 Tlf 97 38 45 00
 Tilbud@dana-vinduer.dk
 www.dana-vinduer.dk

Facadevinduer og -døre i fyrretræ, træ/alu, mahogni og eg

Snit i sidekarm/pladedør mahogni softline · Udadgående døre

DATO:	SIGN:	MÅL:	TEGNINGSNUMMER:
30-10-15	GSC	1:1	SD043-M