

BONDEHUSPROFIL  
KAN VÆLGES

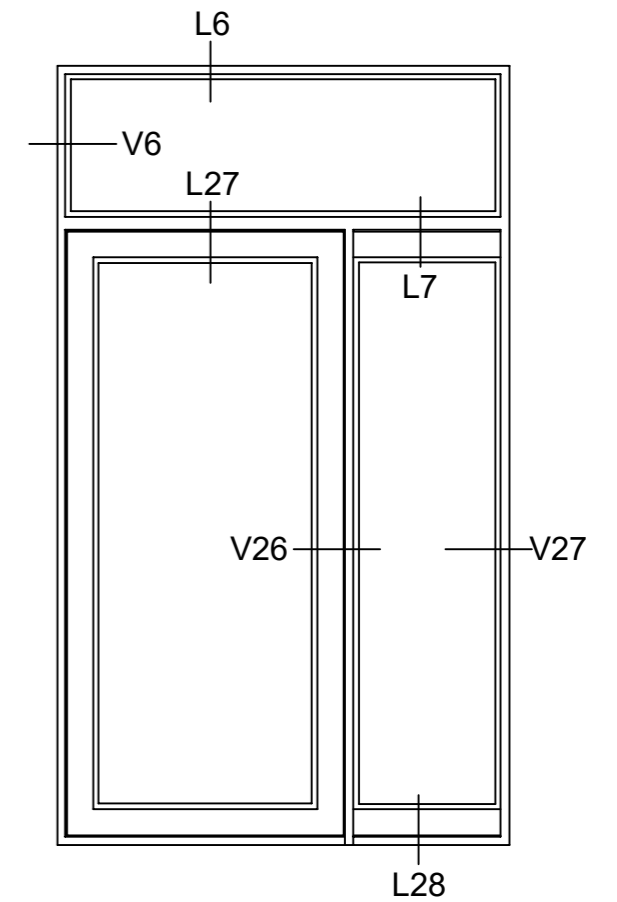
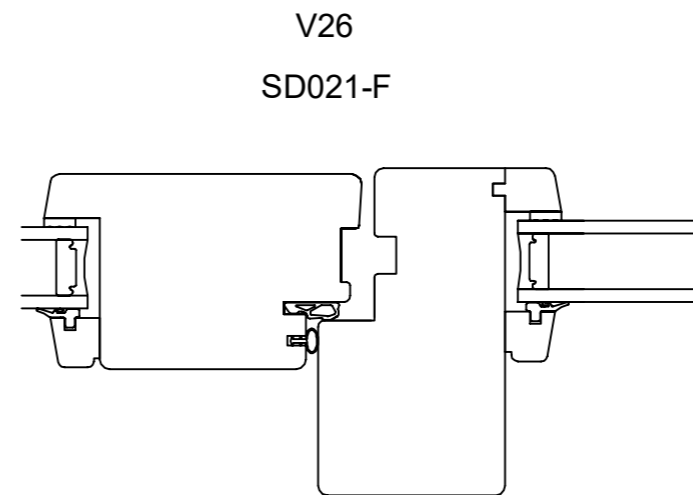
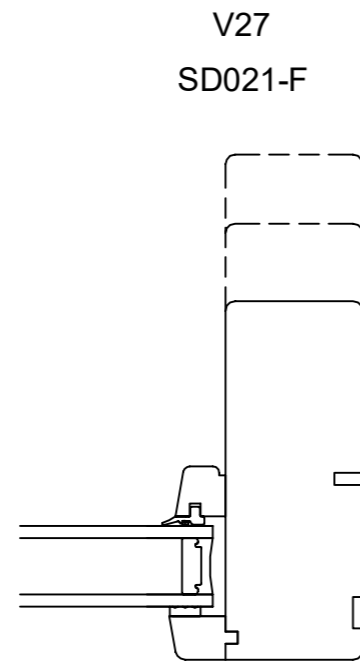
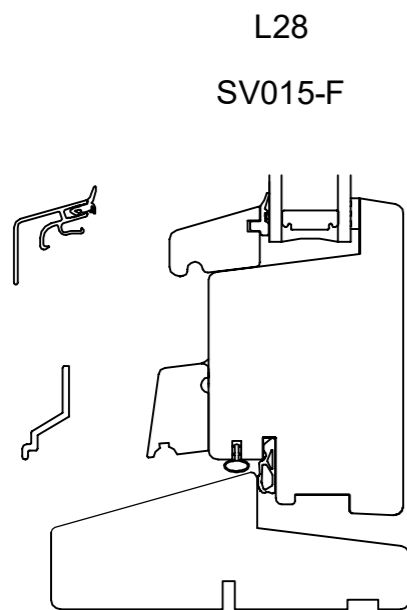
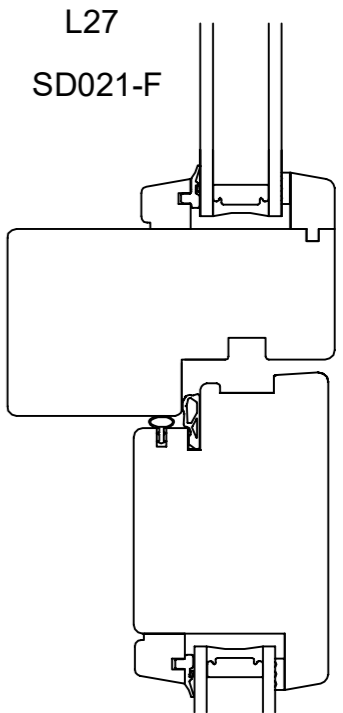

Fabriksvej 4  
6973 Ørnhøj  
Tlf 97 38 45 00  
Tilbud@dana-vinduer.dk  
www.dana-vinduer.dk

Facadevinduer og -døre i fyrretræ, træ/alu, mahogni og eg

DANA TIMBER

|          |       |
|----------|-------|
| DATO:    | SIGN: |
| 05-01-17 | GSC   |
| 22-06-17 | GSC   |
| 09-01-18 | GSC   |

MÅL:  
**1:10**

TEGNINGSNUMMER:  
**INDADGÅENDE  
DØRE 6**

sprosse

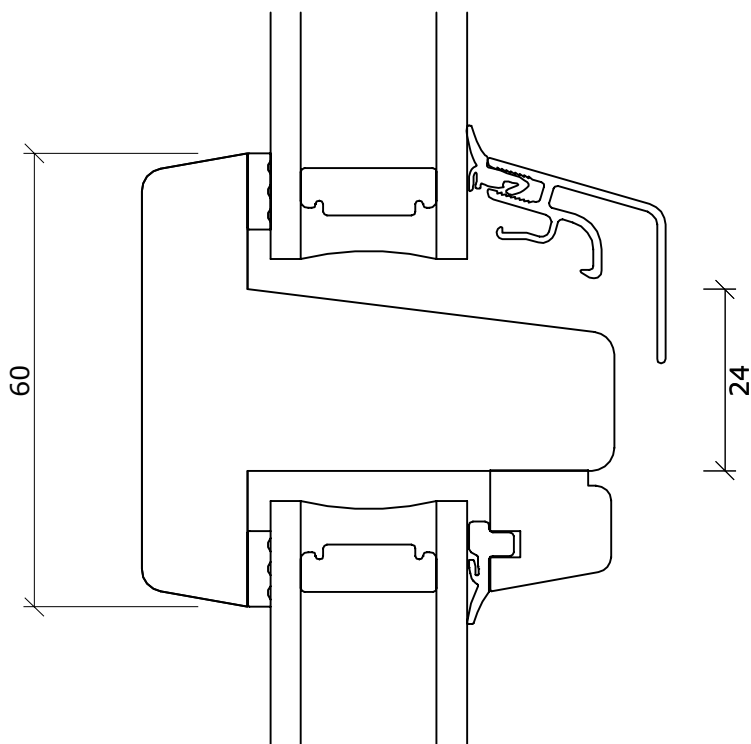
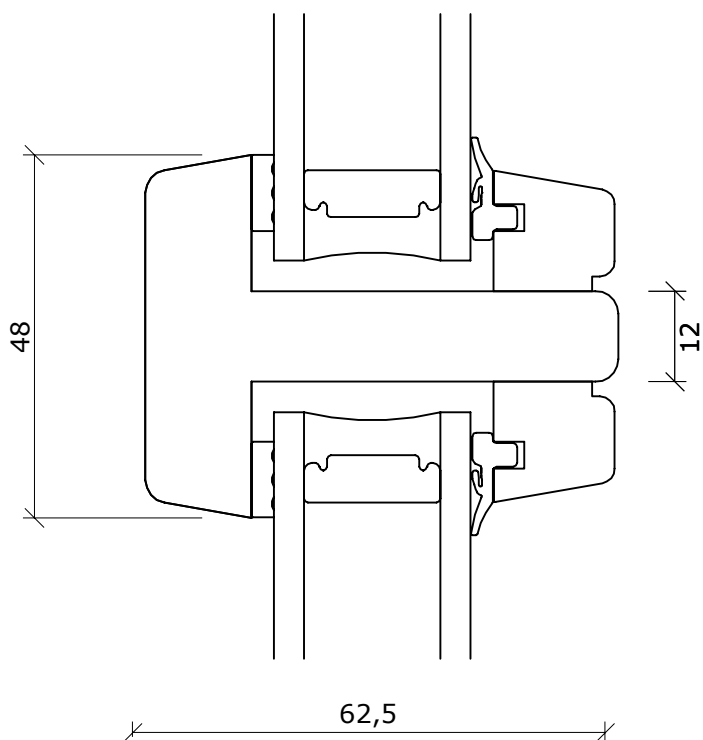
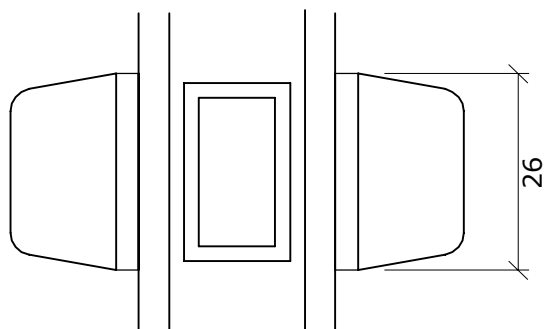

Fabriksvej 4  
6973 Ørnhøj  
Tlf 97 38 45 00  
Tilbud@dana-vinduer.dk  
www.dana-vinduer.dk

Facadevinduer og -døre i fyrretræ, træ/alu, mahogni og eg

Snit i tværsprosser, fyr softline

| DATO:    | SIGN: | MÅL: | TEGNINGSNUMMER: |
|----------|-------|------|-----------------|
| 30-10-15 | GSC   | 1:1  | <b>SV015-F</b>  |
| 16-09-16 | GSC   |      |                 |

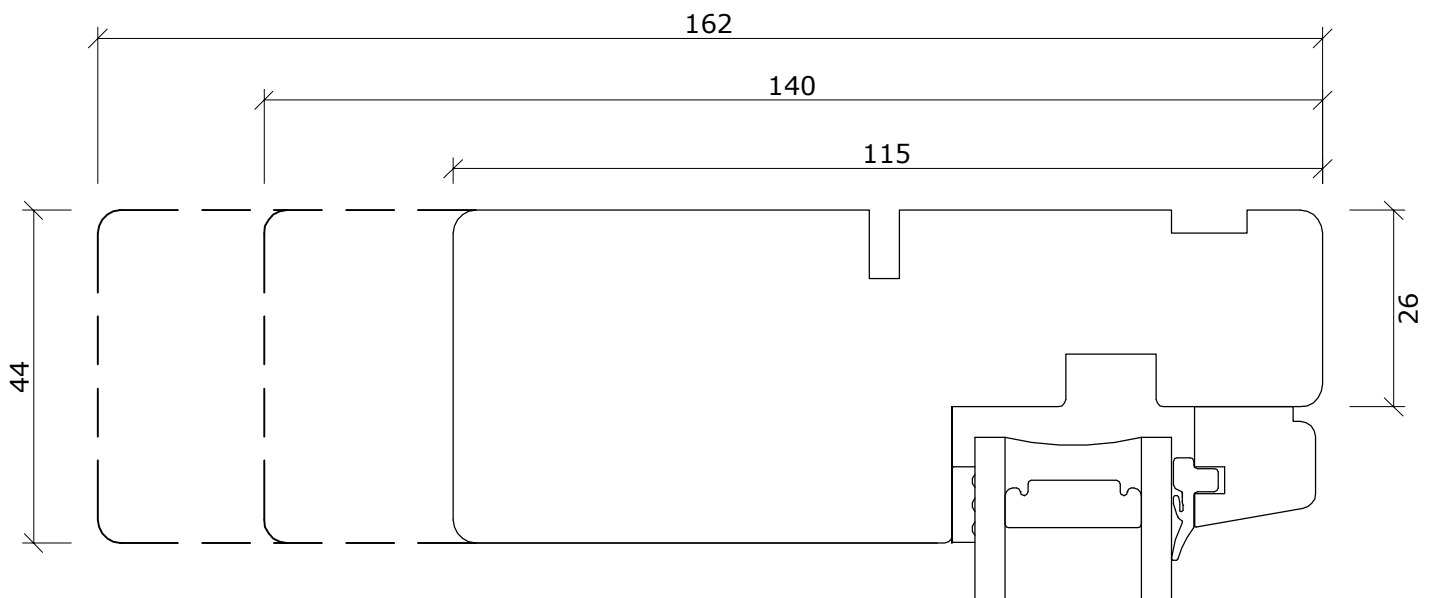

Fabriksvej 4  
6973 Ørnhøj  
Tlf 97 38 45 00  
Tilbud@dana-vinduer.dk  
www.dana-vinduer.dk

Facadevinduer og -døre i fyrretræ, træ/alu, mahogni og eg

### Snit i over-/sidekarm for softline

| DATO:    | SIGN: | MÅL: | TEGNINGSNUMMER: |
|----------|-------|------|-----------------|
| 30-10-15 | GSC   | 1:1  | <b>SV018-F</b>  |
| 12-07-16 | GSC   |      |                 |
| 19-06-17 | GSC   |      |                 |

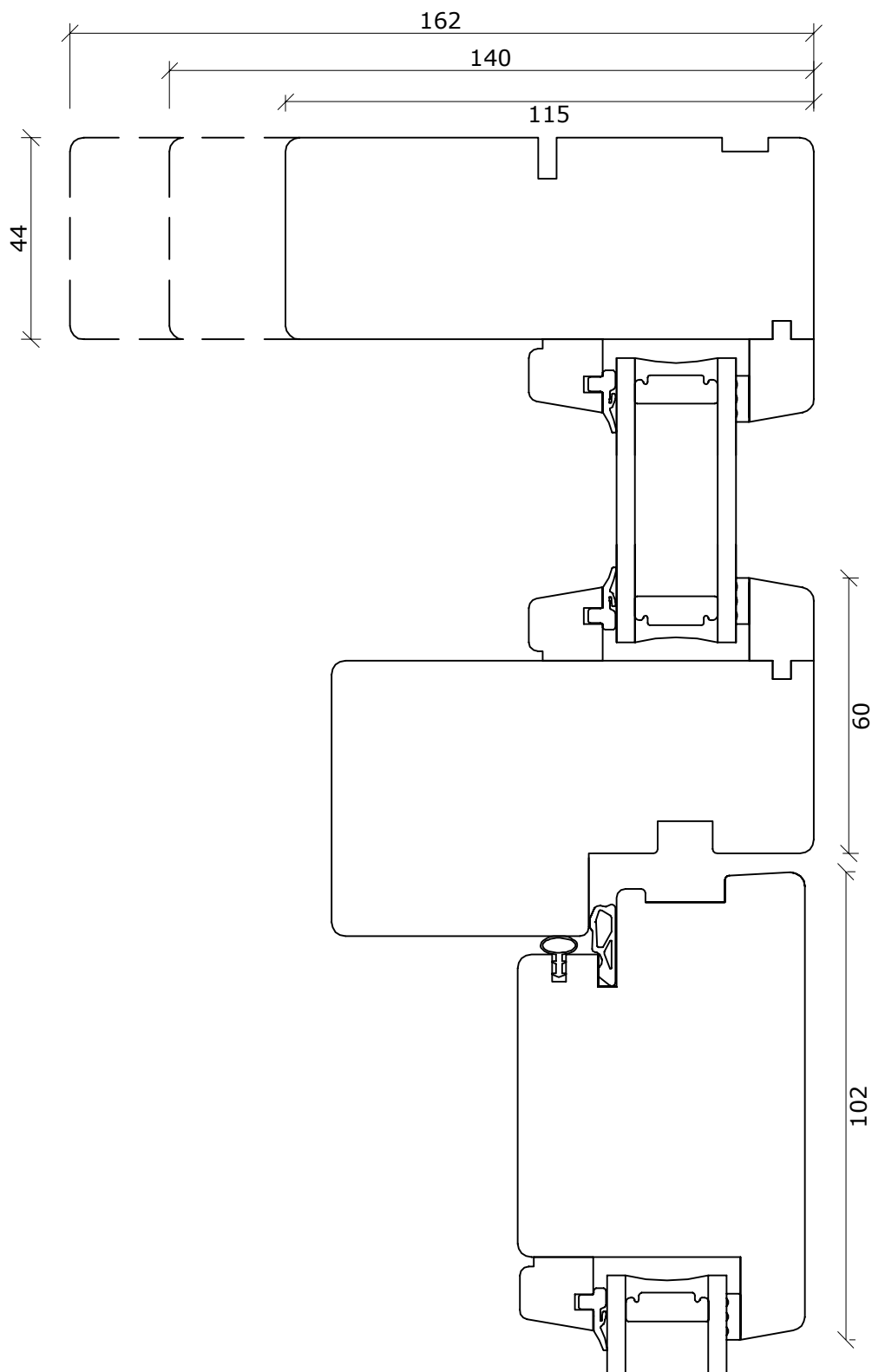

Tegningen er ikke målfast



Fabriksvej 4  
6973 Ørnhøj  
Tlf 97 38 45 00  
Tilbud@dana-vinduer.dk  
www.dana-vinduer.dk

Facadevinduer og -døre i fyrretræ, træ/alu, mahogni og eg

Snit i sidekarm/post integreret sideparti softline  
Indadgående døre

| DATO:    | SIGN: | MÅL:       | TEGNINGSNUMMER: |
|----------|-------|------------|-----------------|
| 30-10-15 | GSC   | <b>1:X</b> | <b>SD021-F</b>  |
| 12-07-16 | GSC   |            |                 |
| 19-06-17 | GSC   |            |                 |

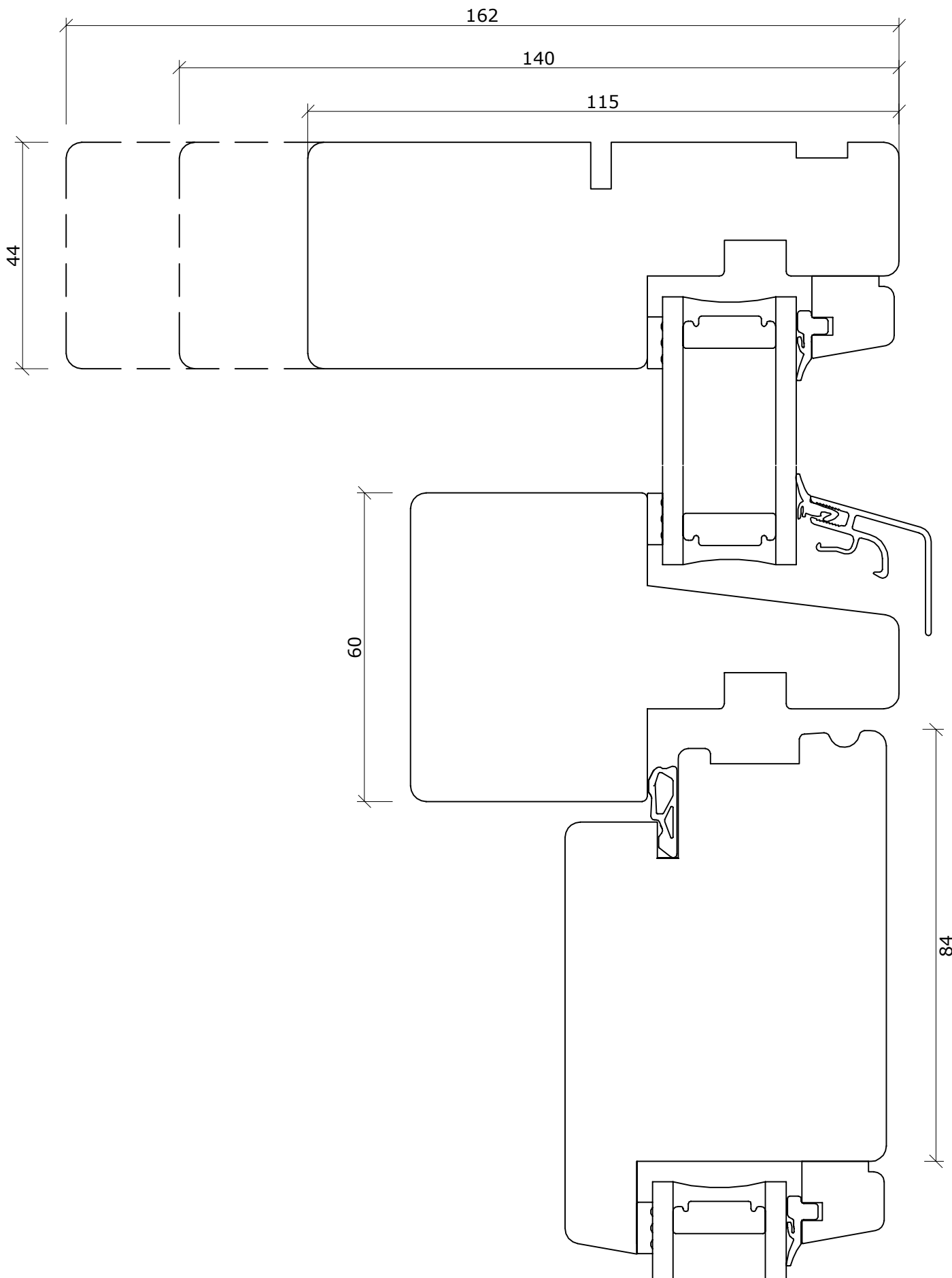

Fabriksvej 4  
6973 Ørnhøj  
Tlf 97 38 45 00  
Tilbud@dana-vinduer.dk  
www.dana-vinduer.dk

Facadevinduer og -døre i fyrretræ, træ/alu, mahogni og eg

Snit i overkarm/post overparti softline Udadgående døre

| DATO:    | SIGN: |
|----------|-------|
| 30-10-15 | GSC   |
| 12-07-16 | GSC   |
| 19-06-17 | GSC   |

MÅL:  
**1:1**

TEGNINGSNUMMER:

**SD038-F**